

# 1. Features & Overview

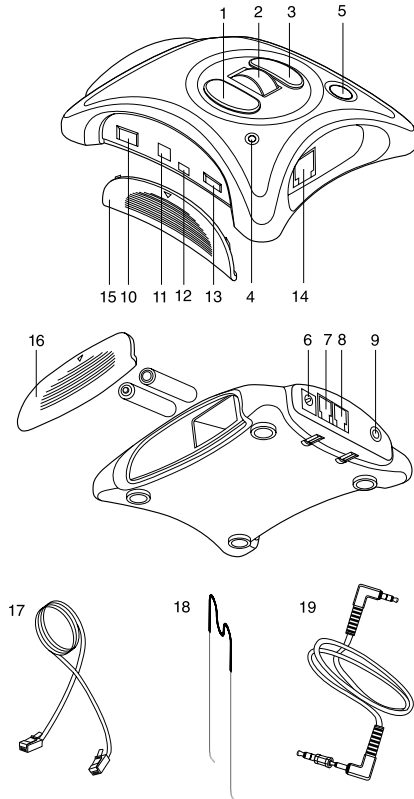

[04]

# Features

## 1. Mute Button (= Battery test)

Press the button to cut off the microphone temporarily. Just depress the button to resume communication with your caller. If the battery test indicator does not light by pressing mute button, replace all the batteries. (Operational battery life: not less than 2,000 hours)

## 2. Listening Volume Controller

You can increase or reduce the volume of your caller's voice.

## 3. Handset / Headset Button

Press it for handset use and depress it for headset use.

## 4. Battery test indicator

Press mute button, if it does not light, replace all batteries.

## 5. Tone control switch

Set the tone Control Switch to be soften or normal.

## 6. External power supply jack



You can use AC power adapter (3V DC) instead of battery.

## 7. Handset Jack (HANDSET)

Connect your handset to this jack.

## 8. Telephone jack (TEL)

Connect a telephone curly cord supplied between the handset jack of your telephone and amplifier.

## 9. Stereo Jack for Recorder

The Stereo plug of recorder can be connected (Option).

## 10. Telephone Compatibility Switch

Compatibility setting between telephone and amplifier.

## 11. Headset Compatibility Switch

Select the knob to the left or right until you can hear.

## 12. Dip switch

For transmission level and dynamic microphone.

[05]

### 13. Transmission volume controller

Set the volume controller by sliding the knob when it becomes optimal sound for your caller.

### 14. Headset Jack

Connect your headset to this jack.

### 15. Security cover

### 16. Battery cover

### 17. Telephone curly cord

Connect this cord between telephone and amplifier.

### 18. Headset Hanger

### 19. Attenuated cord (Option)

Connect the attenuated cord between stereo jack for recorder and recorder's for call recording.

## 2. How to install

### Stage 1. Installing Batteries

We recommend two "AA" alkaline batteries (Not included) for installation. Operational battery life are about 2,000 hours.

- Remove the battery cover on the side of amplifier.
- Install two "AA" alkaline batteries and replace the battery cover
- Press the Mute button to confirm if the batteries are well fitted or not.

\* Note : Alternatively, if you want to use AC power supply (Not included), you can connect AC adapter (3V DC OUT) to external power supply jack. (Feature no.6).

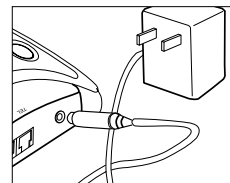
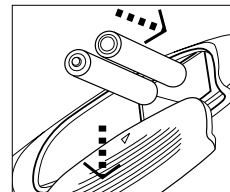

### Stage 2. Connecting to your telephone, headset

1. Unplug your telephone's handset cord from the telephone base and plug it into the handset jack of amplifier (Feature no. 7)

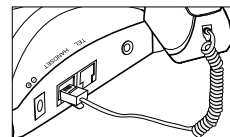
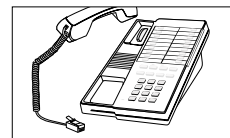

2. Connect a telephone curly cord (Feature no.17) between the handset jack of your telephone and Telephone jack of amplifier (Feature no.8)

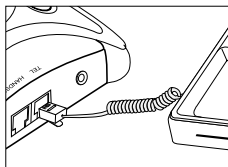

3. Plug one complete headset to the headset jack of amplifier (Feature no.14) located on the front side of the cabinet

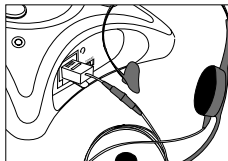

## 3. HOW TO TEST BEFORE USE

### Stage 1. Checking for Compatibility

Wearing the headset, Lift the handset from its cradle, position it off-hook and listen.



#### 1.Compatibility setting between telephone and amplifier

If you can't hear dial tone at factory setting, adjust the compatibility switch between telephone and amplifier as follows

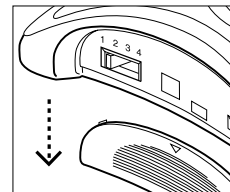

- 1) Remove the Security cover which is located on the side of amplifier.

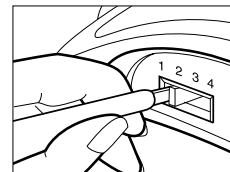

- 2) Slide the compatibility switch by clicks until you can hear a clear dial tone.

- 3) If amplifier does not work with the above compatibility, Your headset may be a dynamic microphone.

Place Dip switch No. 2 to 'OFF' and adjust compatibility switch again until you hear a dialtone as the same manner.

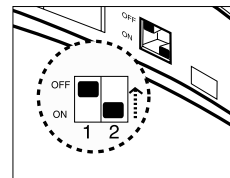

## 2. Compatibility Setting between headset and amplifier

If you use a different headset which is not supplied by us, it can not be worked in our amplifier. In this case, slide the knob to the right(M).

EX) In plantronics headset, slide the knob to the right(M).

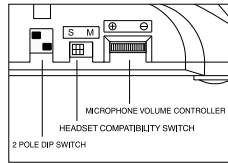

## Stage 2. Checking for Optimal Sound

### 1. Adjustment of listening / Transmission volume

Firstly, place the digit no.5 of listening volume controller to the center and set the white marking part of microphone volume controller to the center.

After the above setting, if the unit is not working properly, use the following adjustments for the best set-up.

- 1) If there is beep sound, slide the Transmission volume controller to the right side(-) for low volume. And if Listening / Transmission is low, slide Transmssion volume controller to the left(+) and increase Listening volume controller at the

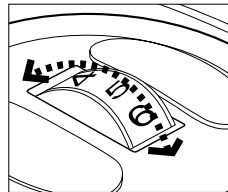
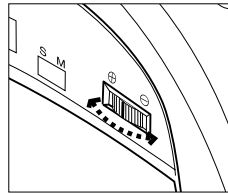

[010]

same time until they are increased for proper level for your caller.

- 2) If there is humming tone, adjust both Listening and Transmission volume controller to the low volume side at the same time.
- 3) If there is high pitched feedback when the volume is set to normal usage levels, adjust the distance of headset boom between the microphone head cap and your mouth. The proper distance is one inch apart from your mouth.



### 2. Adjustment of dip switch (= Transmission level)

If the transmission volume is too big or too low even though you did all the above settings, it may be bad telephone line condition or low output of telephone transmission level.

If the TX volume is too big, place switch no.1 to "OFF" (factory set-up) to decrease it.

If the TX volume is too low, please switch no.1 to "ON" to increase it.

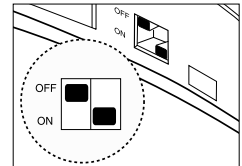

[011]

### 3. To record a call

Connect an Attenuated Cord (Feature No.19) optionally supplied between Stereo jack for recorder and your computer or exterior recorder. Operated recording function of the computer or exterior recorder. You may need this record for your job references or to report the record to the other party or your boss.

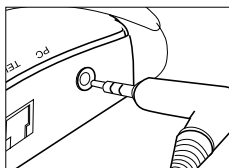

### 4. Mute

If you press Mute button during telephone call, the music from computer or audio device is transmitted to the other party while the microphone is cut off.

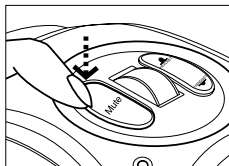

## 4. Operation

**Receiving by headset** : Depress the headset/handset button(feature no.3), wear the headset. Lift the handset from its cradle and place it "off hook" when the telephone rings. You can answer the telephone by headset.

**Making a call by headset** : Depress the headset /handset button (feature no.3), wear the headset. Lift the handset from its cradle and place it "off hook" and dial after listening tone signal. To terminate a call, hang up the telephone handset.

**Handset use** : Press the headset /handset button (feature no.3), lift the handset, dial after listening dial tone.

\* Off hook lever use( option) : "Off-hook Lever" eliminates the need for you to lift the handset, just pull the lever when the telephone rings, you can talk with the caller without completely removing the handset from its cradle.

**Remarks** : if your telephone has a program for "headset" use or a switch that can be used by headset, you won't need to lift the handset every receiving or call. Just press a button for making or receiving a call. The telephone that has the headset-use button will vary from one telephone to another, but most often it is the "line button".

Check your telephone's manual for details. Most of key phone systems have this program.

## 5. TROUBLESHOOTING

The following information covers common problems and suggests solutions.

If the amplifier and headset are not operating properly, follow the suggestions in this section

### **CALLERS CAN'T HEAR ME AND I CAN'T HEAR MY CALLERS**

1. Check the installation. Check all cords are properly connected.
2. Check the Handset / Headset button. Push the button down for handset use, and push-up for headset operation.

### **CALLER'S VOICE IS LOW OR DISTORTED.**

1. Adjust the Listening Volume Controller on the amplifier.(feature no.2)
2. Replace your batteries. For best results, use Duracell alkaline batteries.

### **CALLERS CAN'T HEAR ME, BUT I CAN HEAR THEM.**

1. Be sure the microphone is properly positioned, about one inch from the corner of your mouth.
2. Adjust the Transmission volume controller (Feature no.13)

### **THE PEOPLE I'M TALKING TO SAY I SOUND UNCLEAR OR TOO FAR AWAY.**

Adjust the position of your microphone.

The best place for the microphone is not directly in front of your mouth, but near the corner of it, similar to the way you position the telephone handset. In this position, you can pick up the sound waves from your speech, but not the air moving from your mouth and nose.

### **MY VOICE ECHOES OR I SOUND LIKE I'M IN A TUNNEL**

Slide the Transmission volume Controller to the left side for a lower volume.